

MEDIDOR DE VAZÃO TIPO ENGRENAGENS PARA LIQUIDOS VISCOSOS



- Measuring range:
0.008-2 to 1-250 L/min
- Measuring accuracy:
 ± 0.3 up to $\pm 1\%$ of actual flow
- p_{max} : 400 bar
- t_{max} : 150 °C
- Process connection:
G 1/8, G 3/8, G 1/2, G 1 female thread
- Material:
Cast iron or stainless steel

SERIE DZR COM ENGRENAGENS CILINDRICAS

Description

The KOBOLD Gear Wheel Flow Meter series DZR have been designed for a cost effective flow measurement for viscous fluids. The measuring unit consists of a pair of gear wheels which is moved by the flow according to the principle of gear wheel motor. The bearings are – according to the material combination – either ball bearings or gliding bearings. The different versions vary through different housing materials, lubrication properties, through the medium being used and the accuracy.

Version

- DZR-1 Flow measurement, Hydraulic test rigs for: Oil, Brake fluid, Diesel, Skydrol lubricating, low viscous
- DZR-2 Oil batching, Batching installations Gear Box Oil, lubricating, mid viscous
- DZR-3 Consumption measurement Printing machines, Offset colour, lubricating, high viscous
- DZR-4 Ratio control, 2-Component plant, Polyol, Isocyanate, Glue, Resin, Silicone, low lubricating, mid viscous
- DZR-5 Batch control, painting plant, clear paint, Clearance volume sealing, low lubricating, mid viscous
- DZR-6 Flow measurement, painting plant, Solvent, lubricating, mid viscous

Technical data

Accuracy: see specifications table
 Repeatability: < 0.1% of measured value
 Max. Pressure: 400 bar
 (DZR-x001 up to DZR-x010)
 315 bar
 (DZR-x011 up to DZR-x015)
 Media temperature: -30...+120 °C (standard)
 -30...+150 °C (option)
 Ambient temperature: -30...+80 °C
 Viscosity range: see specifications table

Materials

Housing:
 DZR-1/2/3/4: GGG 40
 DZR-5/6: st.st. 1.4404
 Gear wheels:
 DZR-1/2/3/4: steel 1.7139
 DZR-5/6: st.st. 1.4462
 Bearings: see specifications table
 Seals: FPM, EPDM or PTFE/FEP
 Output signal: 2 pulse output signals
 90° ±30° phase shift
 Pulse form: rectangular
 duty cycle 1:1 (±15%)
 short circuit proof
 Pulse amplitude: ≥ 0.8 U_B
 Power supply: 12-30 V_{DC}
 (Polarity reversal protected)
 8-12 V_{DC} (option K/T)
 Max. power consumption: 0.6 W
 Max. output capacity: 0.3 W
 Electr. connection: plug acc. DIN 43650
 Explosion protection: on request
 Protection: IP 65
 Weight: see dimensions table

Model	Resolution pulses/L
DZR-x001/-x002	40 000
DZR-x003	25 000
DZR-x005	4082
DZR-x006/-x007	2500
DZR-x008/-x009/-x010	965
DZR-x011/-x012	333
DZR-x013/-x014/-x015	191

Specifications

	DZR-1	DZR-2	DZR-3	DZR-4	DZR-5	DZR-6
Media viscosity	low	medium	high	medium	medium	low
Lubrication properties of media	good	good	good	bad	bad	good
Bearing	ball bearing	ball bearing	bronze gliding bearing	tungsten c.gl. bearing	tungsten c.gl. bearing	ball bearing
Material	cast iron	cast iron	cast iron	Guss	stainless steel	stainless steel
Accuracy of measured value	±0.3%	±0.5%	±1%	±0.5%	±0.5%	±0.3%
	from 20 mm ² /s	from 50 mm ² /s	from 100 mm ² /s	from 100 mm ² /s	from 100 mm ² /s	from 20 mm ² /s
Range Code						
001	0.008...2 L/min	-	-	-	-	0.008...2 L/min
002	-	-	-	-	0.02...2 L/min*	-
003	0.02...4 L/min	-	-	-	-	-
005	0.16...16 L/min	0.16...16 L/min	-	0.16...16 L/min	0.16...16 L/min	0.16...16 L/min
006	-	-	-	0.2...30 L/min	-	-
007	0.2...40 L/min	-	-	-	-	-
008	-	-	0.6...40 L/min	-	-	-
009	-	-	-	0.3...60 L/min	0.3...60 L/min	-
010	0.4...80 L/min	0.4...80 L/min	-	-	-	0.4...80 L/min
011	-	-	-	0.6...100 L/min	0.6...100 L/min	-
012	0.6...160 L/min	-	-	-	-	0.6...160 L/min
013	-	-	1.2...80 L/min	-	-	-
014	-	-	-	1...160 L/min	1...160 L/min	-
015	1...250 L/min	1...250 L/min	-	-	-	1...250 L/min

*Accuracy: ±3%

Order Details (example: DZR-1 001 S10 F S 0)

Model	Range*	Mech. connection (female thread)	Seal	Electronics	Electr. connection (c/w plug)
DZR-1 DZR-2 DZR-3 DZR-4	001 003 005	S10 = G 3/8 side H10 = G 3/8 backward	F = FPM E = EPDM P = PTFE/FEP	S = up to 120°C/ 24 V _{DC} R = up to 120°C/ 12 V _{DC} H = up to 150°C T = up to 150°C/ 12 V _{DC}	0 = without cable 1 = 5 m cable (4-wire) 2 = 10 m cable (4-wire)
	006 007 008 009 010	S15 = G 1/2 side H15 = G 1/2 backward			
	011 012 013 014 015	S25 = G 1 side H25 = G 1 backward			
DZR-5 DZR-6	001 002	R06 = G 1/8 side			
	005	R10 = G 3/8 side			
	008 009 010	R15 = G 1/2 side			
	011 012 013 014 015	R25 = G 1 side			

*The range of the corresponding model can be taken from the schedule »specifications«

Dimensions DZR-1, DZR-2, DZR-3, DZR-4 W/O connecting plate

Measuring range-code	Weight kg	Dimensions (mm)											
		A	C	D	F	G _s	G _n	J	K*	L*	M*	N*	P*
001/002	1.8	85	10	60	50	101	114	-	70	40	20	6,5	M6
003	2	85	9	60	56	107	120	-	70	40	20	6,5	M6
005	2	85	13	60	57	108	121	-	70	40	20	9	M6
006/007	3.7	100	17	90	63	114	127	-	80	38	34	16	M8
008/009/010	5.2	120	13	95	72	123	136	15.5	84	72	35	16	M8
011/012	9	170	18	120	89	140	153	46.5	46	95	50	25	M12
013/014/015	13	170	22	120	105	156	169	46.5	46	95	50	25	M12

DZR-...SO/DZR-...XO

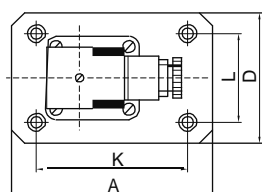
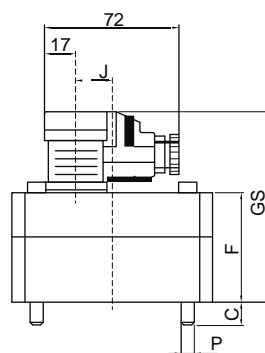

DZR-...HO

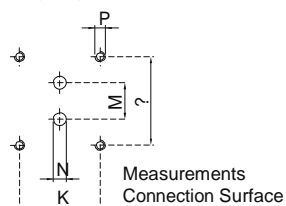
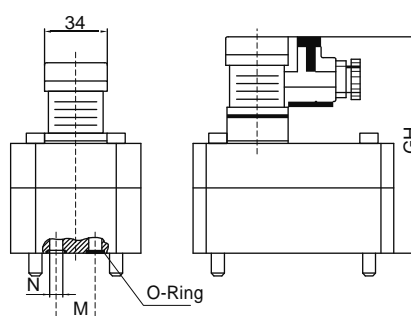

Dimensions connection plate for DZR-1, DZR-2, DZR-3, DZR-4

Connection side ports

Meas. range	Weight kg	Dimensions (mm)																	
		A	B	C	E	F	G	H	J	K	L	M	N	P	R	c	d	e	f
001-005	1.8	85	90	35	65	76	7	11	7	70	40	20	6,5	M6	17	0.7	25	G3/8	13
006-007	2.7	100	110	37	86	96	7	11	7	80	38	34	16	M8	18.5	0.7	29	G1/2	15
008-010	2.9	100	120	37	80	106	7	11	7	84	72	35	12	M8	17.5	0.7	29	G1/2	15
011-015	14	160	165	80	140	145	9	15	9	46	95	50	25	M12	28	1	42	G1	19

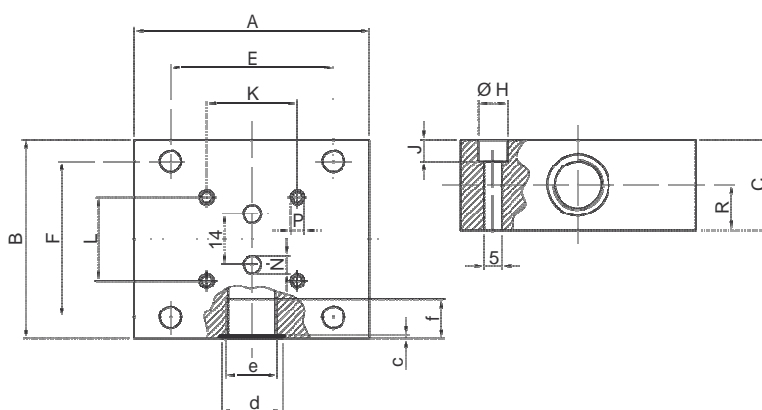

Connection bottom ports

Meas. range	Weight kg	Dimensions (mm)																	
		A	B	C	E	F	G	H	J	K	L	M	N	P	R	c	d	e	f
001-005	1.6	85	90	35	65	76	7	-	-	70	40	20	6,5	M6	28	0.7	25	G3/8	12
006-007	2.7	100	110	37	86	96	7	11	7	80	38	34	16	M8	46	0.7	29	G1/2	15
008-010	2.9	100	120	37	80	106	7	-	-	84	72	35	12	M8	50	0.7	29	G1/2	14
011-015	9.6	160	165	55	140	145	9	15	9	46	95	50	25	M12	55	1	42	G1	18

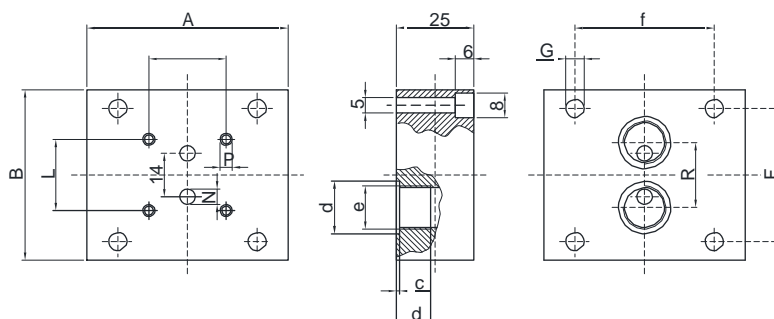

Dimensions DZR-5, DZR-6

Meas. range	Weight kg	Dimensions (mm)												
		A	B	C	D	E	F	G _s	G _H	H	J	K	L	P
001-002	3	G 1/8	9	17	94	86	55	106	119	15	-	70	40	6.7
005	3.1	G 3/8	13	25	94	90	57	108	121	16	-	70	40	6.7
008-010	7	G 1/2	15	29	124	120	72	123	136	22	15.5	84	72	9
011-012	15.9	G 1	19	42	170	162	89	140	153	30	46.5	46	50	13
013-015	18.7	G 1	19	42	170	162	105	156	169	30	46.5	46	50	13

DZR-...SO/DZR-...XO

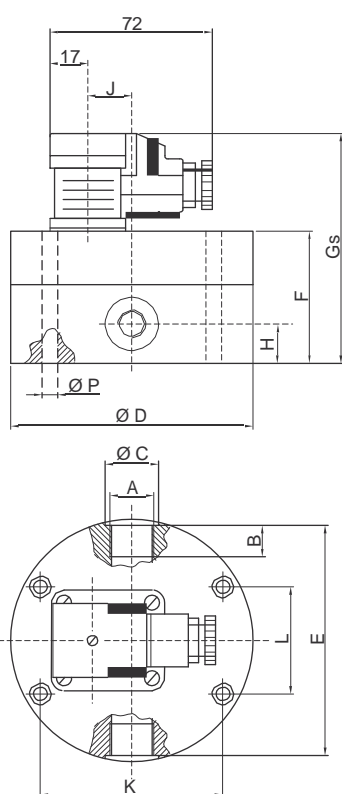

DZR-...HO

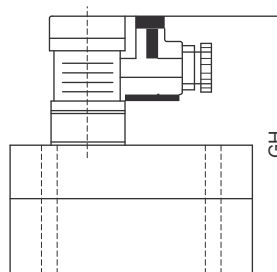

Pressure loss diagrams

DZR-1001, DZR-6001

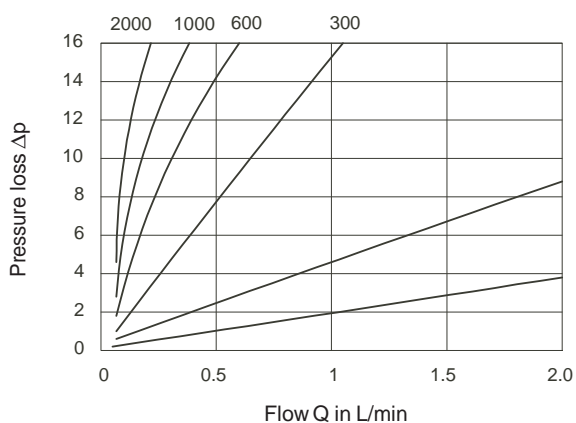

DZR-1003

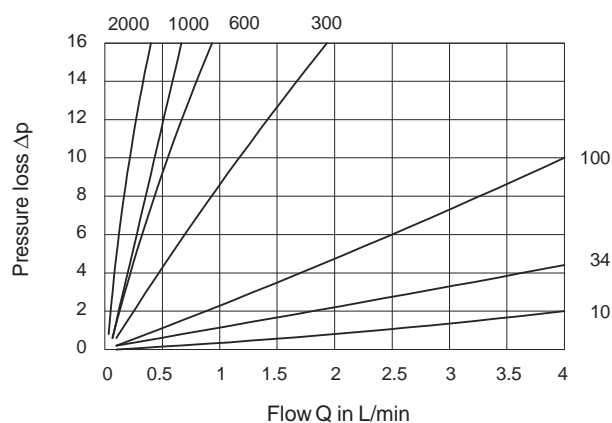

DZR-1005, DZR-2005, DZR-6005

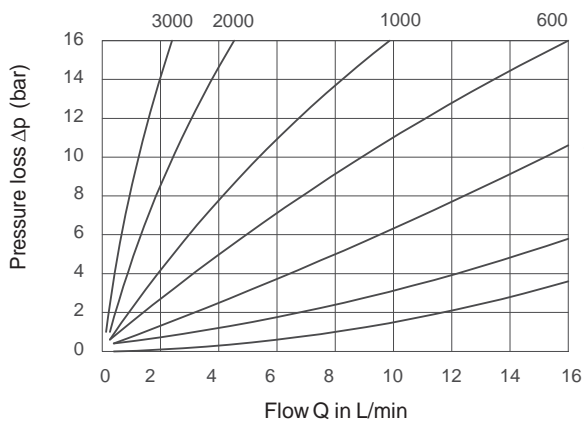

DZR-1007

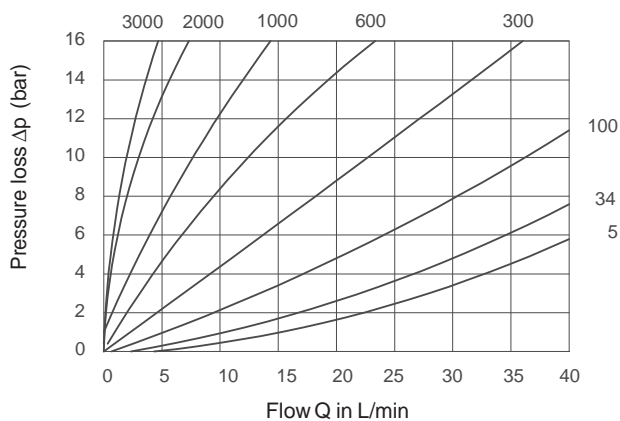

DZR-1010, DZR-2010, DZR-6010

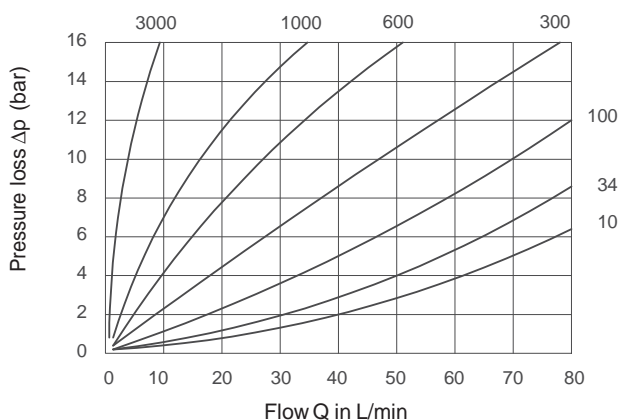

DZR-1012, DZR-6012

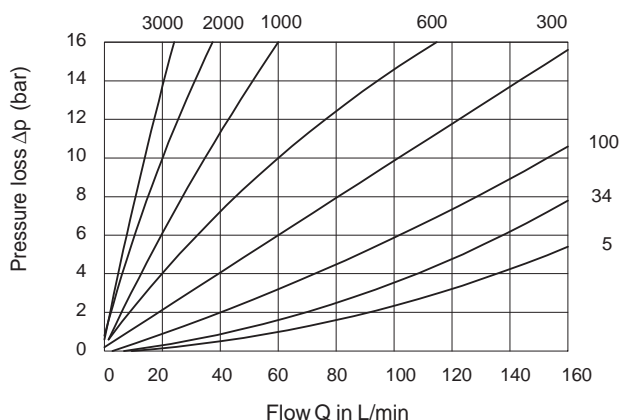

DZR-1015, DZR-2015, DZR-6015

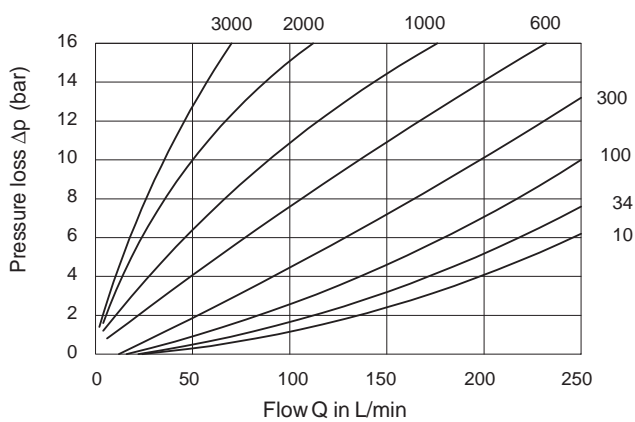

DZR-3008

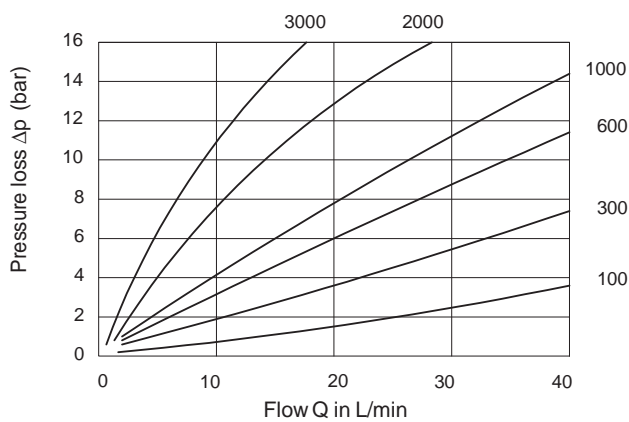

DZR-3013

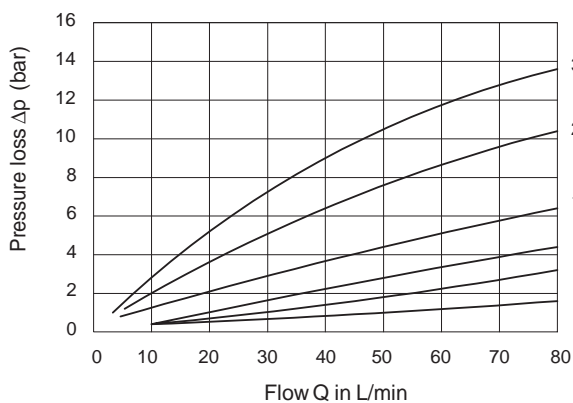

DZR-4005, DZR-5005

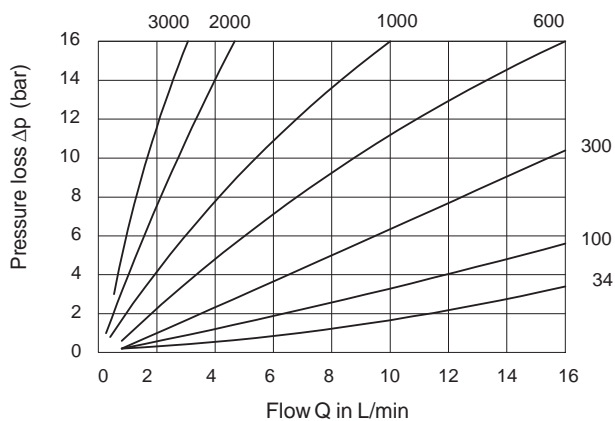

DZR-4006

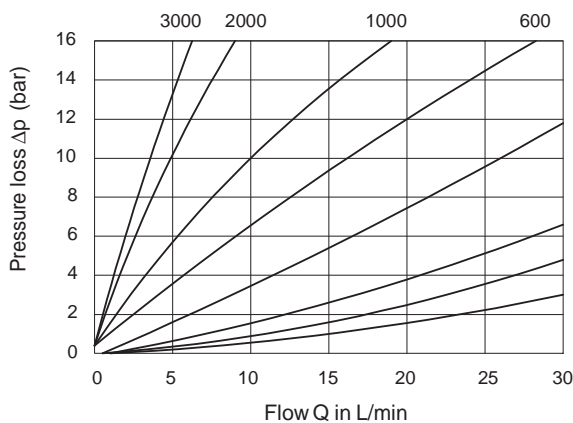

DZR-4009, DZR-5009

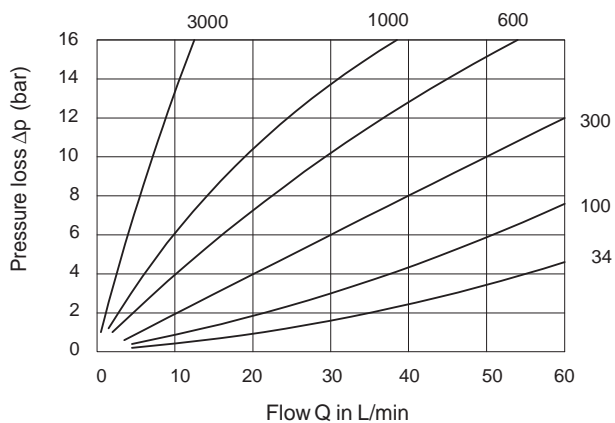

DZR-4011, DZR-5011

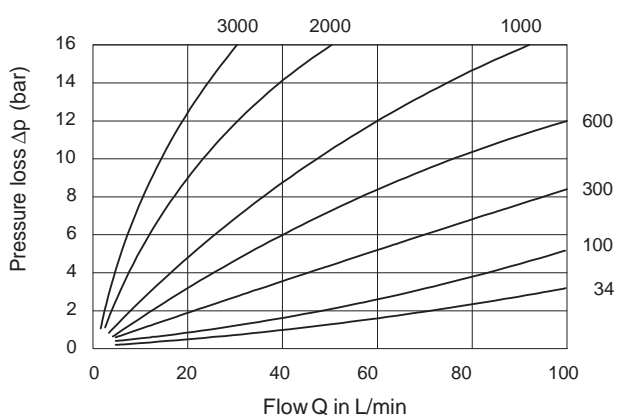

DZR-4014, DZR-5014

